



basic education

Department:
Basic Education
REPUBLIC OF SOUTH AFRICA



ANNUAL NATIONAL ASSESSMENT 2015 GRADE 1 ENGLISH HOME LANGUAGE TEST

MARKS: 20

MARKS

TIME: 1 hour

PROVINCE _____

DISTRICT _____

CIRCUIT _____

SCHOOL _____

EMIS NUMBER (9 digits)

--	--	--	--	--	--	--	--	--

CLASS (e.g. 1A) _____

SURNAME _____

NAME _____

GENDER (✓)

BOY

GIRL

DATE OF BIRTH

C	C	Y	Y	M	M	D	D
---	---	---	---	---	---	---	---

This test consists of 9 pages, excluding the cover page.

Instructions to the teacher:

1. Read each question/instruction slowly and audibly to the learners.
2. Read the questions/instructions twice while the learners follow in their booklets.
3. Do not explain the questions/instructions.
4. Give them time to write answers independently in the spaces provided.
Do not lead the learners to the answers.
5. Once the learners have completed a question, continue to read the next question.
6. Follow the same procedure for each question to the last question.
7. Do the practice exercises with the learners.

Practice exercises:

1. Cross (x) the letter in the block above the correct answer.

This is a ...

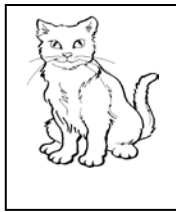

A	B	C	D
dog.	cow.	hen.	cat.

You have answered the question correctly if you crossed (x) 'D'.

2. Number the sentences 1-4 in the boxes to show the correct order in which you would brush your teeth.

Wet the toothbrush.	
Rinse your mouth.	
Brush your teeth.	
Put toothpaste on the toothbrush.	

You have answered the question correctly if you have numbered the sentences in the correct order: 1, 4, 3, 2.

3. Circle the letter next to the correct answer.
I wear a ... when I play cricket.

- A hut
- B hat
- C hot
- D hit

You have answered the question correctly if you have circled 'B'.

In your test you will answer more questions like the ones you have just completed.

The test starts on the next page.

1. Look at the pictures below.

With what sound does each picture start?

Write the letter in the box below the picture.

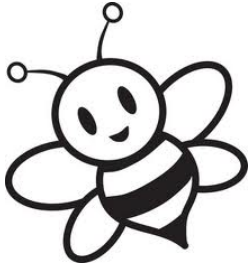

1.1

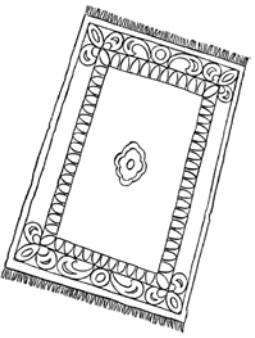

1.2

2. Use the words in the boxes to label the pictures.

dog	mug	pen	fan
-----	-----	-----	-----



2.1.....



2.2.....

3. Read the story and answer Questions 3.1-4.

Today is Ben's sixth birthday. His sister Pam gives him a cricket bat for his birthday. He is excited to use his bat. Ben and his family go to the park in their car. Ben puts on his cap to play cricket. Dad bowls the ball to him. Ben hits the ball hard and runs fast. Mom and Pam cheer him on. The family have fun in the park.

[Source: DBE]

3.1 Place a cross (x) in the box next to the correct answer.

What is the best title (name) for the story?

Playing with friends	<input type="checkbox"/>
Ben's new cap	<input type="checkbox"/>
Fun at the park	<input type="checkbox"/>

3.2 Answer the question.

How old is Ben?

Ben is years old.

3.3 Number the sentences 1-3 in the boxes to show the correct order.

Ben puts on his cap.	
They have fun in the park.	
Ben and his family go to the park.	

4. Circle the letter next to the correct answer.

Why did Ben put on his cap?

He put on his cap to ...

- A have fun.
- B play cricket.
- C bowl the ball.
- D run in the park.

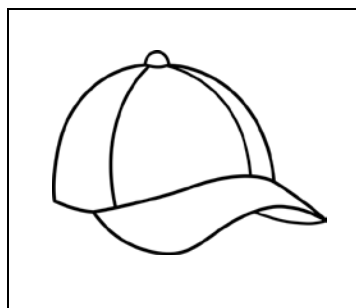

5. Look at the picture.

What does this picture show?



This is a picture of a

6. Put a cross (x) on the letter above the correct answer.
What is the heaviest object?

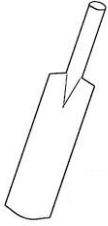
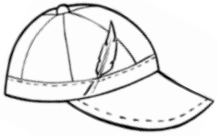
A	B	C	D
			

7. Draw a line from the sentence to the correct picture.

Dad plays cricket.	Ben puts on his cap.
--------------------	----------------------

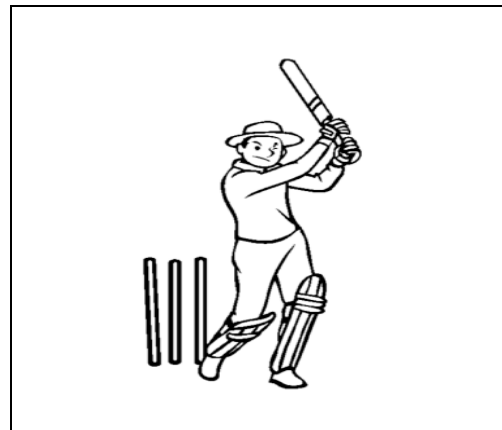

8. Rewrite the sentence.
Use a capital letter and a full stop.
ben plays cricket in the park

.....

9. A noun is a naming word.

9.1 Circle the letter next to the correct noun.

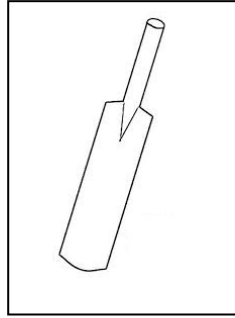

The boy hits the ball with a ...

A car.

B net.

C bat.

D pin.

9.2 Fill in the missing noun.

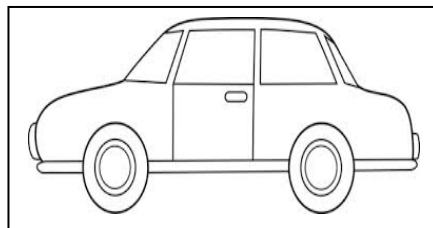

Mum drives a

10. Look at the picture below.

10.1 Write one sentence about the picture.



.....

10.2 Write **two** sentences about the picture. Remember to start your sentences with a capital letter and end with a full stop.

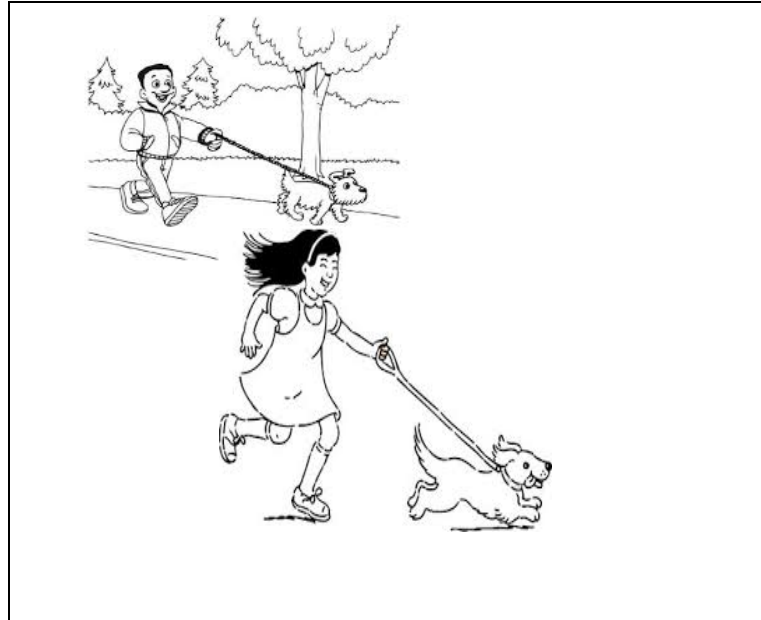

.....

.....

.....

.....

.....

.....

.....

.....

.....

.....

TOTAL: 20

